

Leaking Pipe Line or Landscaping Over-watering?

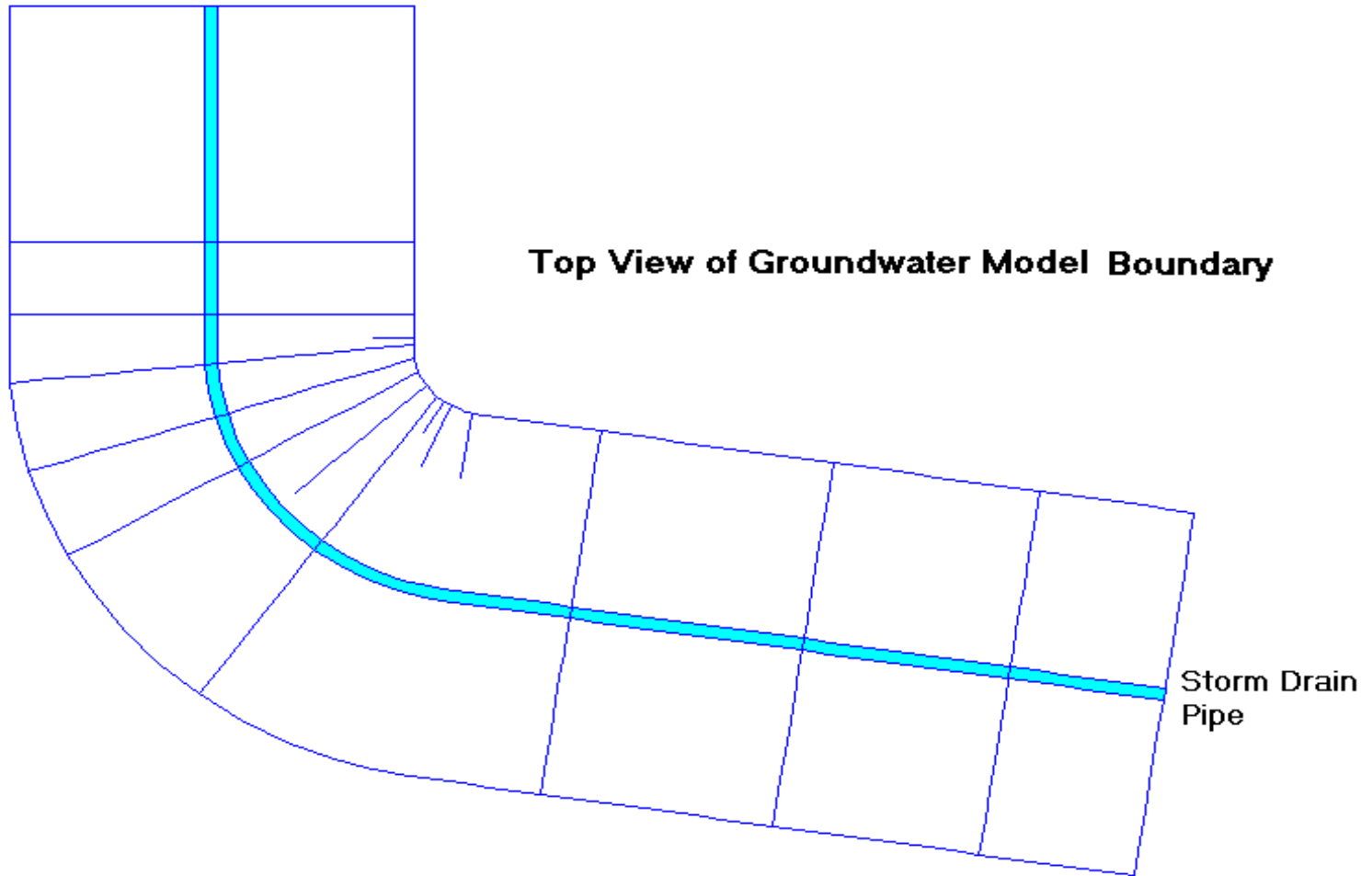

Leaking Pipe Line or Landscaping Over-watering?

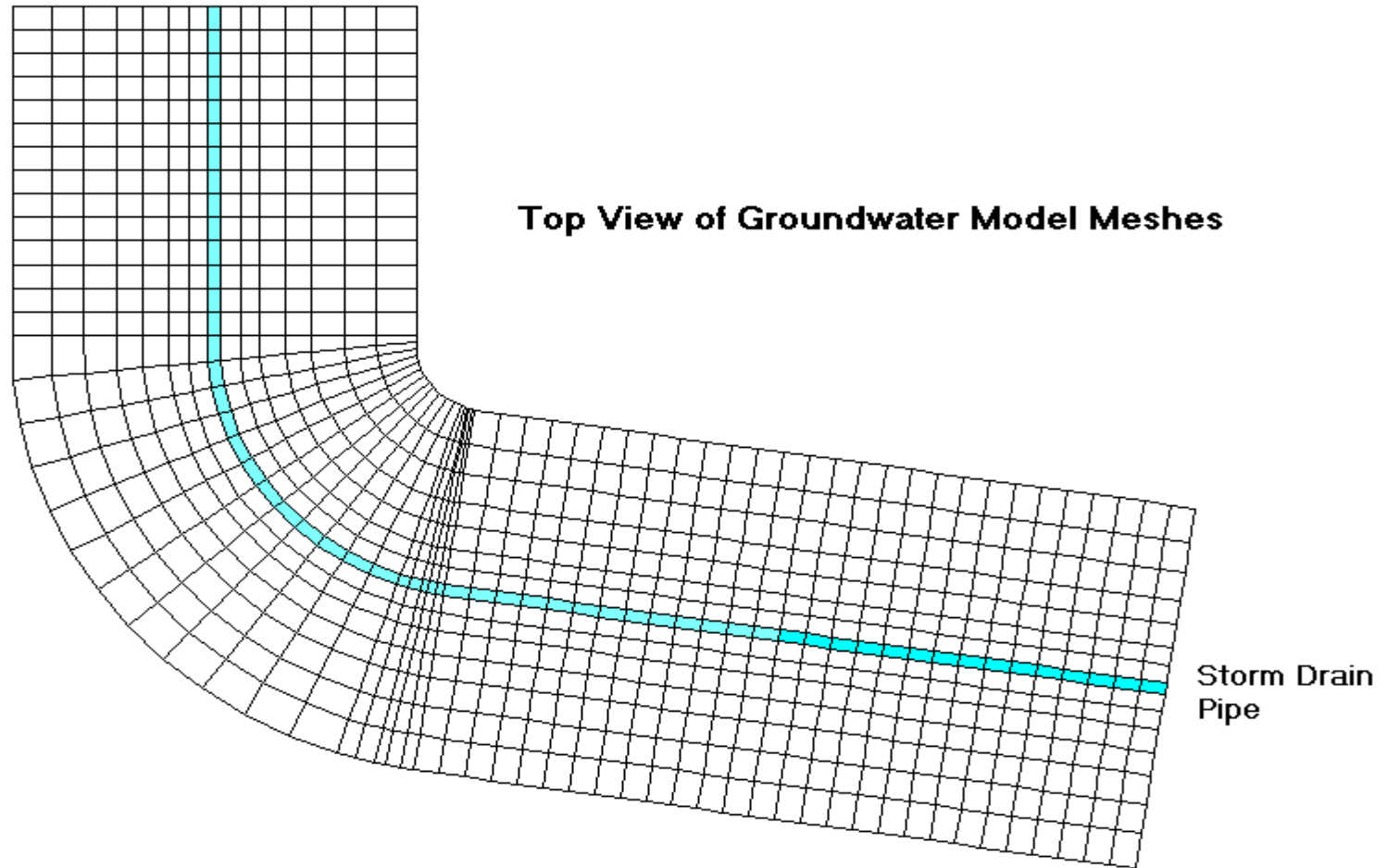

Leaking Pipe Line or Landscaping Over-watering?

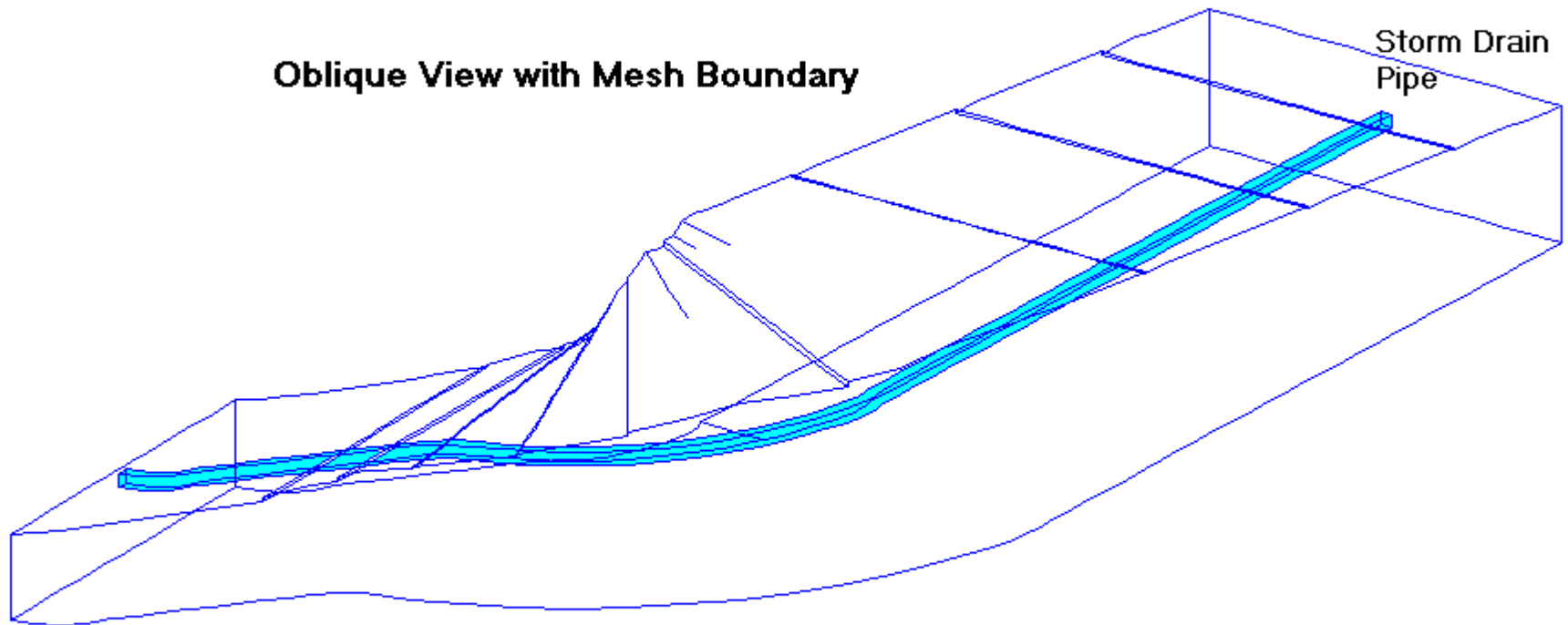

Leaking Pipe Line or Landscaping Over-watering?

Oblique View of Groundwater Model Meshes

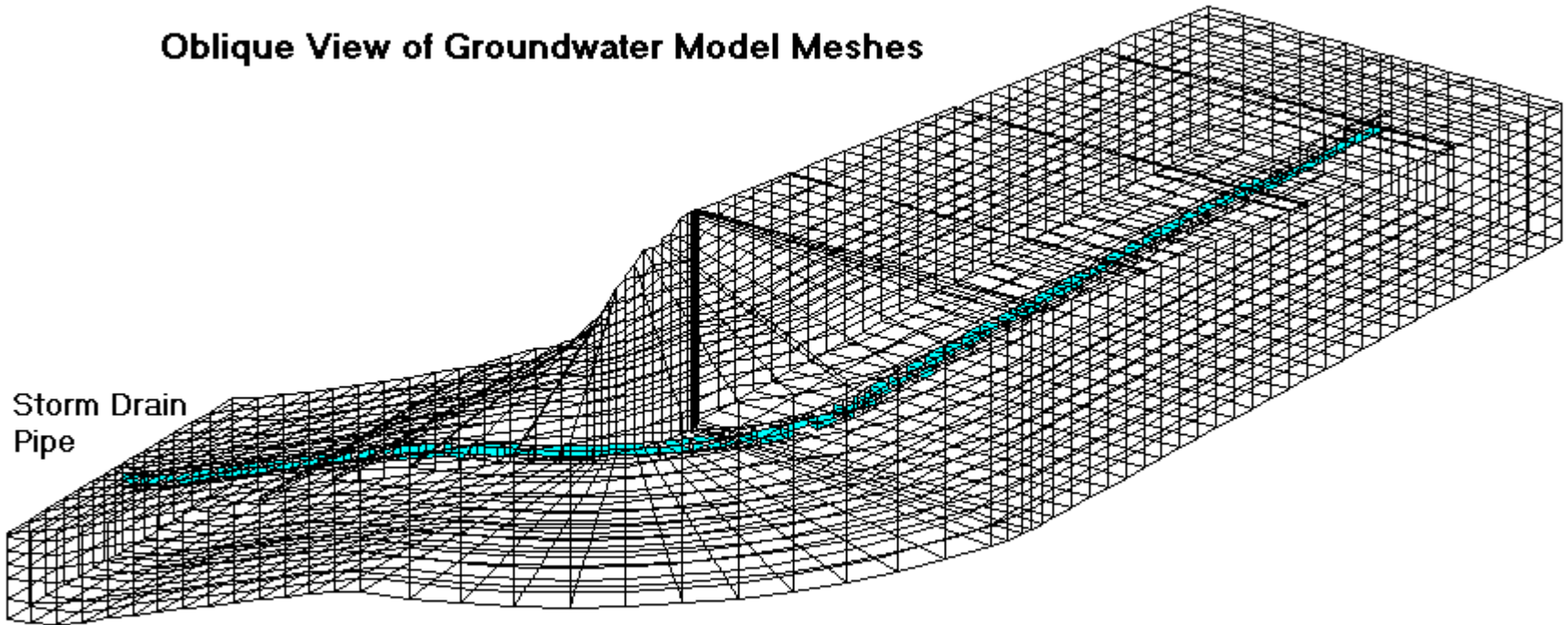

Leaking Pipe Line or Landscaping Over-watering?

**Oblique View with Cross-section
through Center of Storm Drain Pipe**

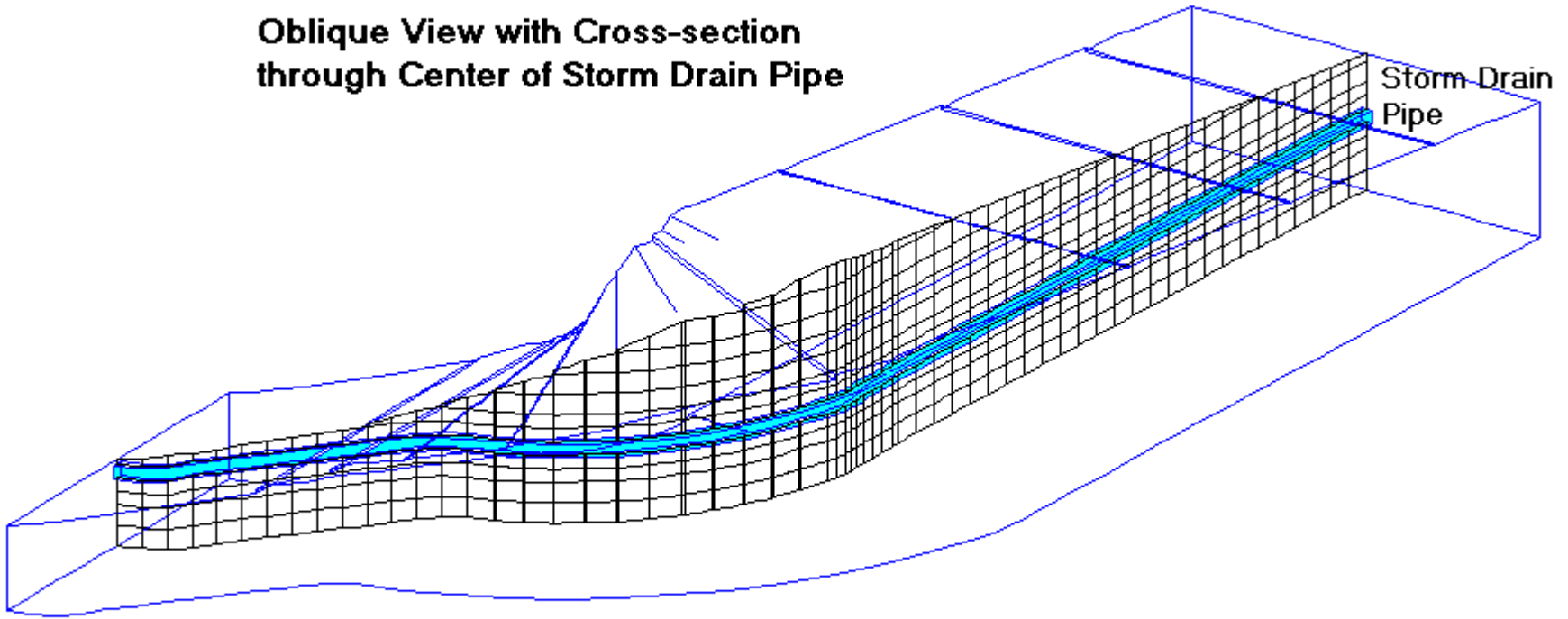

Leaking Pipe Line or Landscaping Over-watering?

Soil Moisture Contents @ 21-Day of Simulation

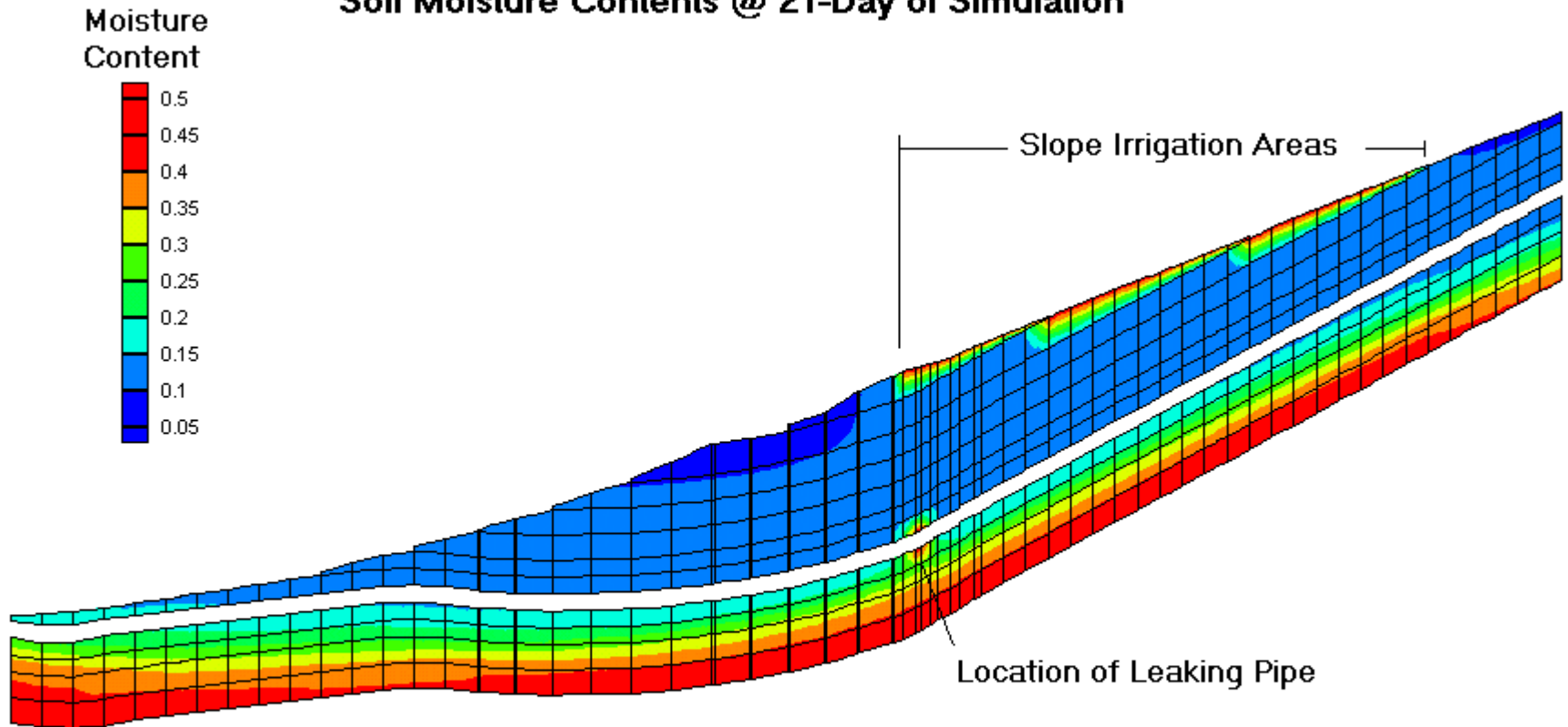

Leaking Pipe Line or Landscaping Over-watering?

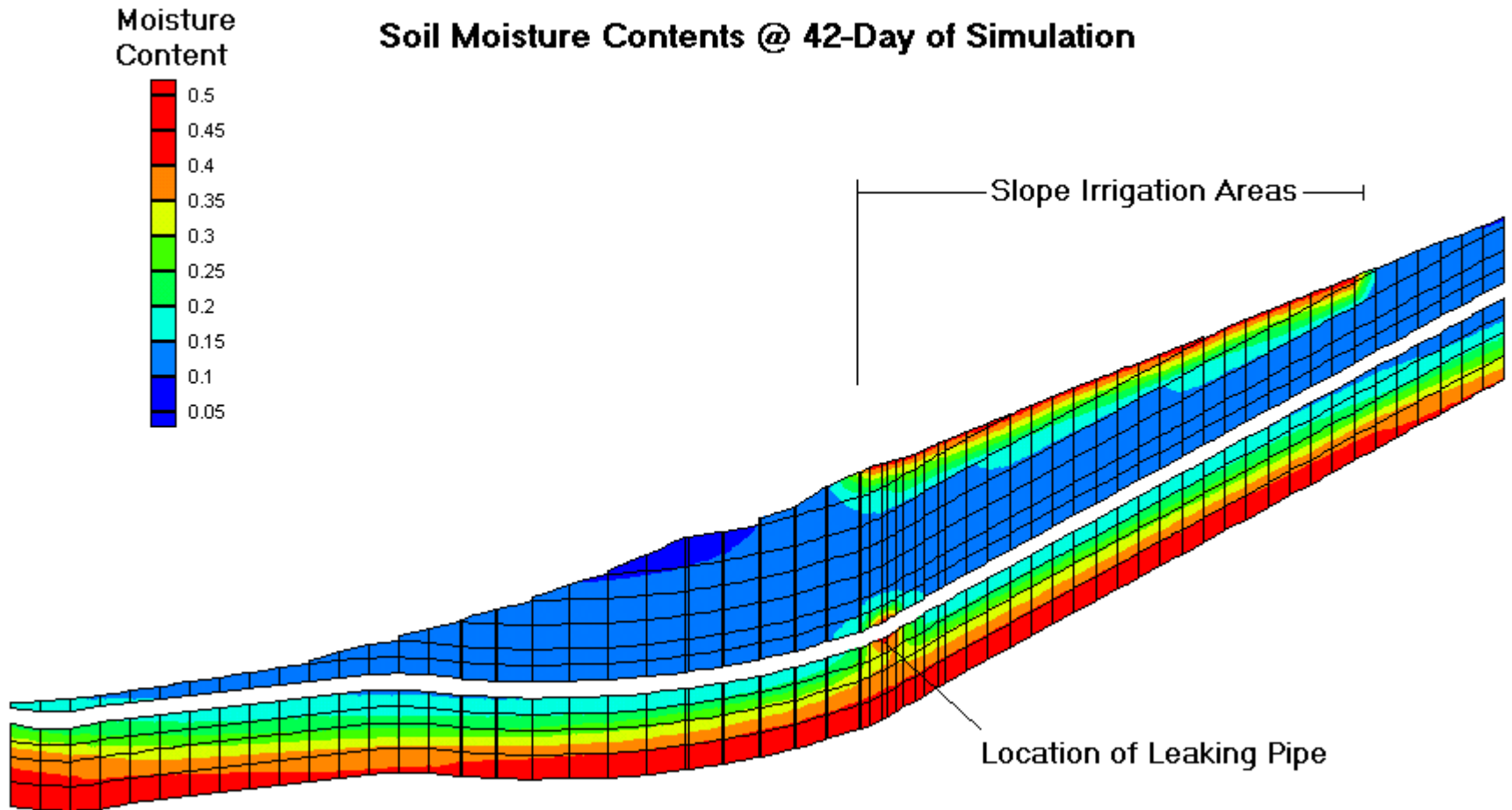

Leaking Pipe Line or Landscaping Over-watering?

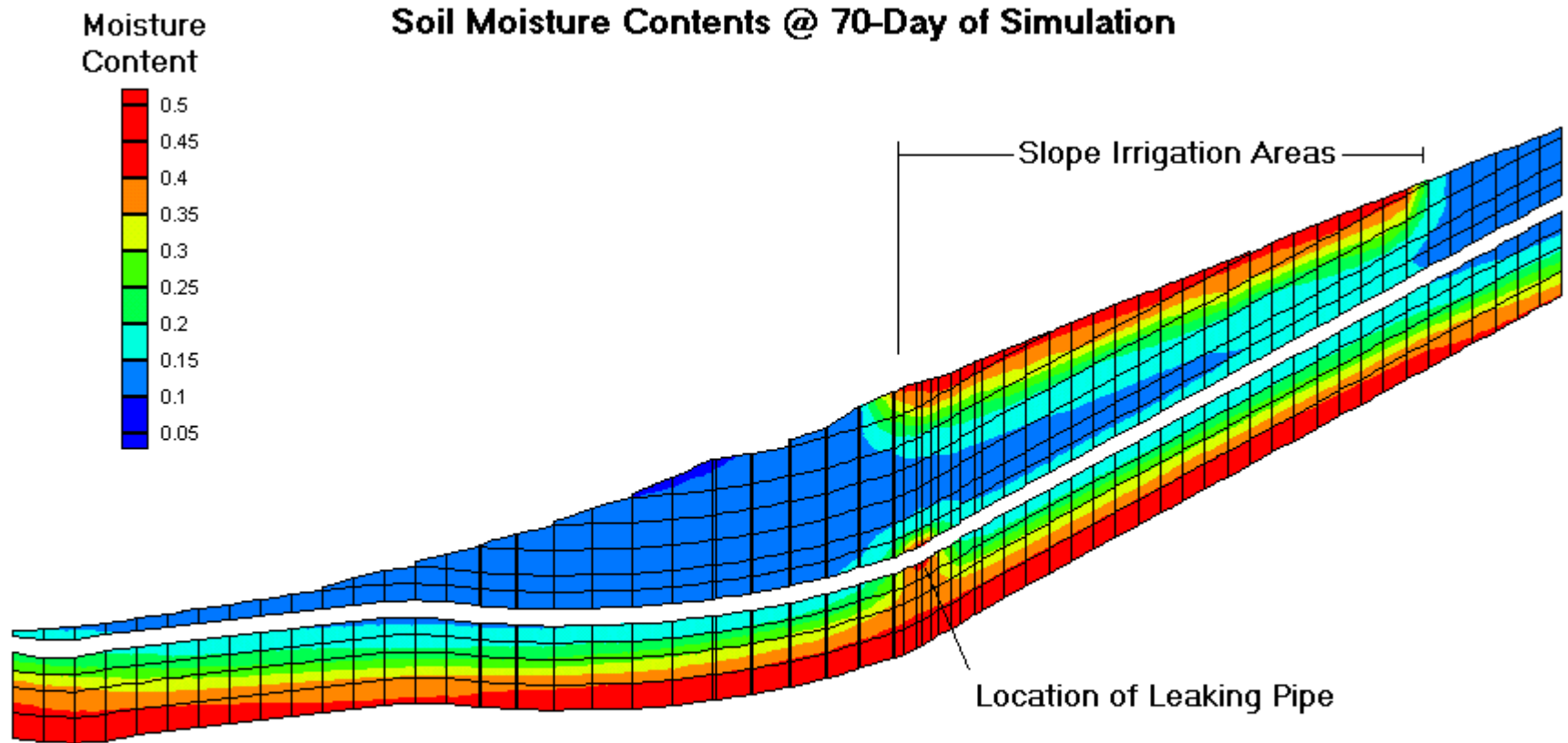

Leaking Pipe Line or Landscaping Over-watering?

Soil Moisture Contents @ 105-Day of Simulation

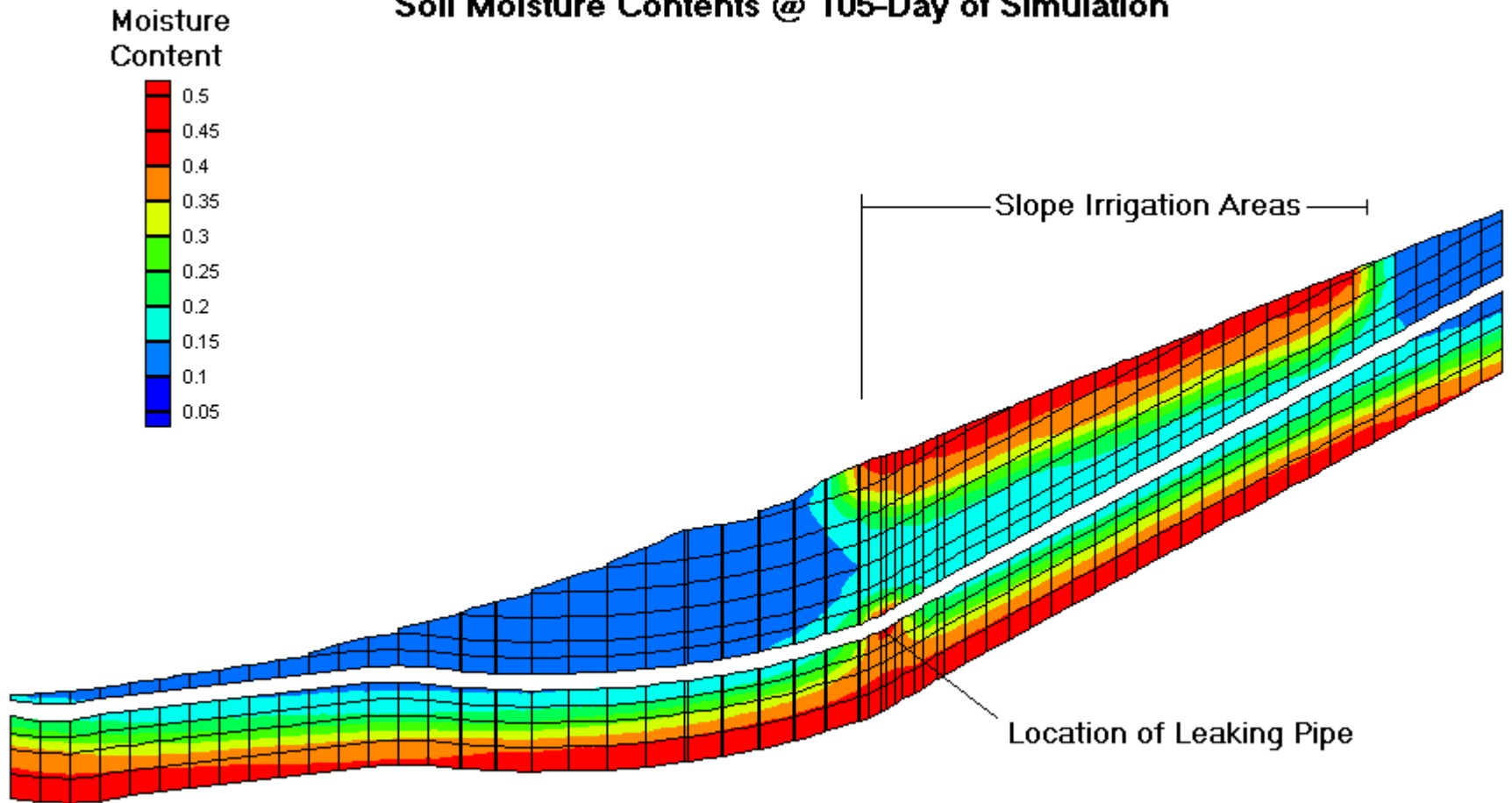

Leaking Pipe Line or Landscaping Over-watering?

Moisture Content

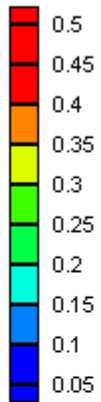

Soil Moisture Contents @ 196-Day of Simulation

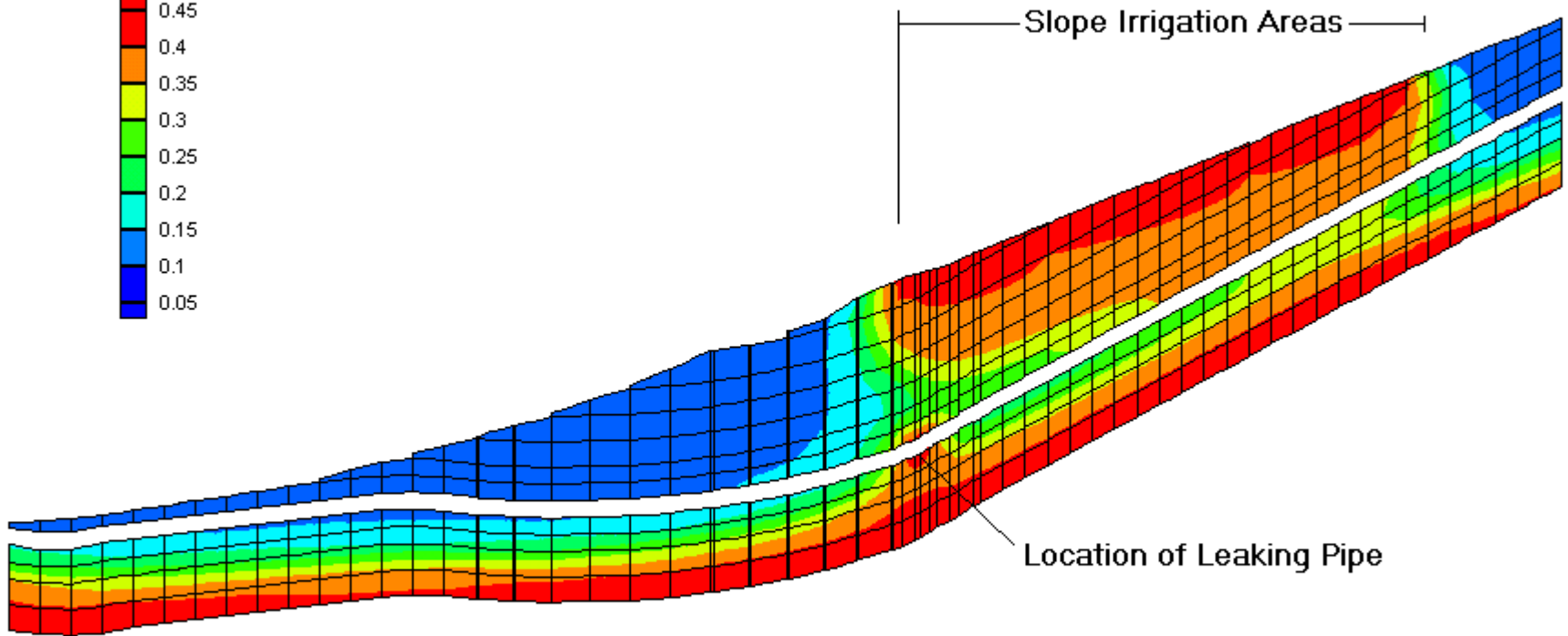

Leaking Pipe Line or Landscaping Over-watering?

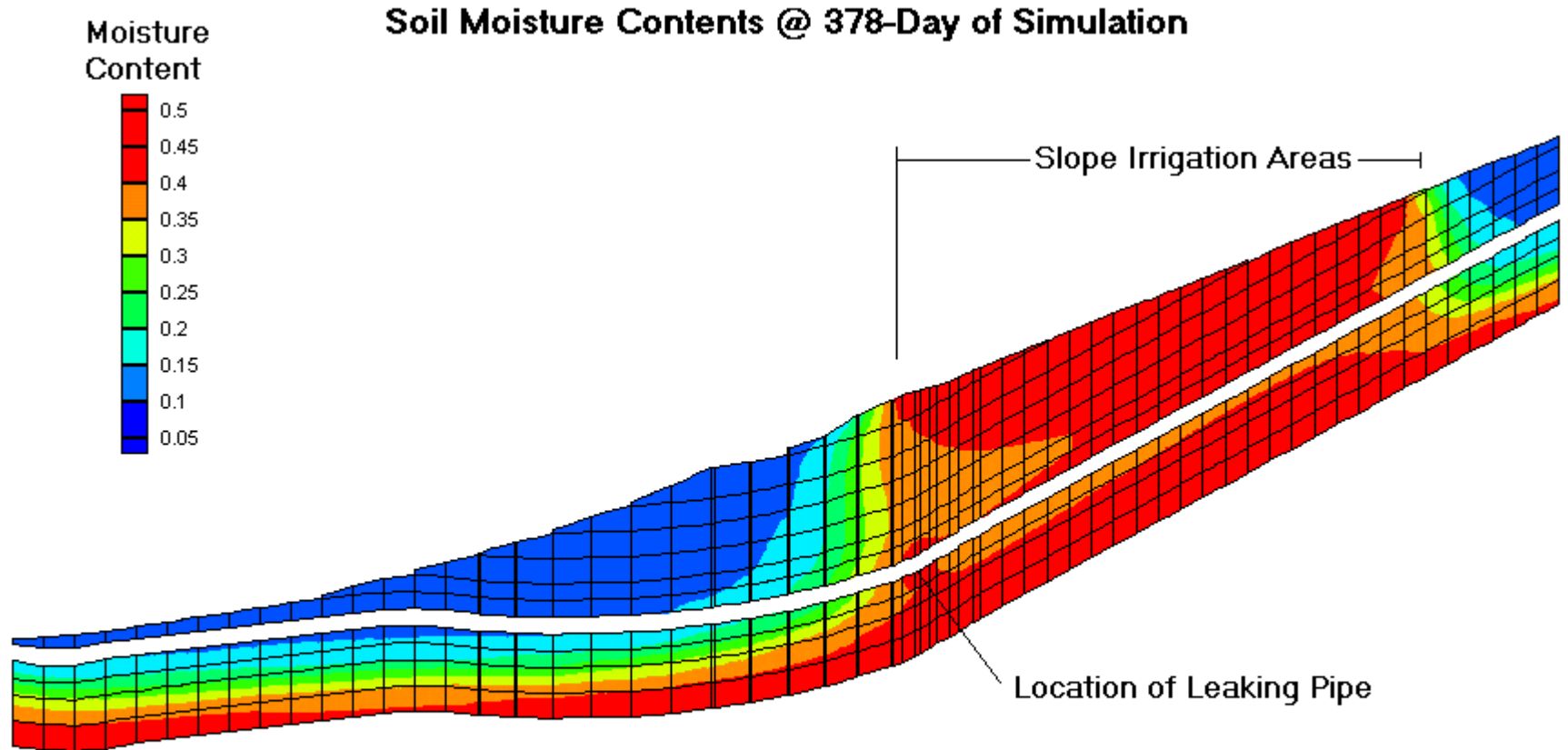

Leaking Pipe Line or Landscaping Over-watering?

Moisture
Content

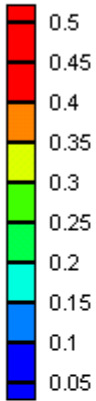

Soil Moisture Contents @ 742-Day of Simulation

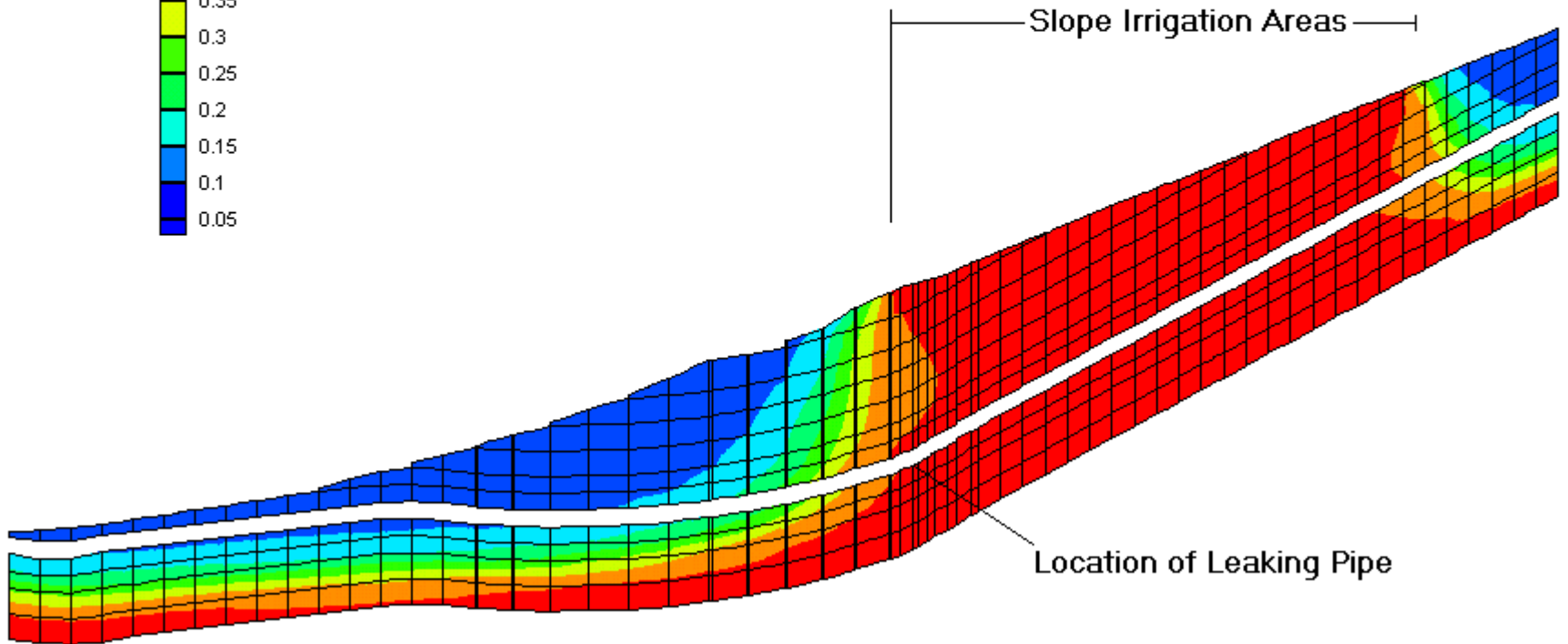

Leaking Pipe Line or Landscaping Over-watering?

